

User manual

DESIGN & TECHNICAL INFORMATION

OPERATION & CONTROL

MAINTENANCE & SERVICE

Exhaust air filter, article No: Q120101
Supply air filter, article No: Q120100

*Easy to
maintain*

*Efficient
heat recovery*

*Low noise
level*

*Low energy
consumption*



Contains checklist for installation, adjustment, and start-up!

Checklist	page	3
Quick guide		
Short menu overview		4
Filter change		4
Design & technical information		
Product description		5
Placement guide		5
Casing		
Filter, exhaust air		
By-pass damper		
Fan, exhaust air		
Fan, supply air		
Heat exchanger		
Filter, supply air		
Adjustable feet		
Condensate drain		
Control panel		
Reheater		
Operating / Alarm Indication		
Functional diagram		6
Technical specification		7
Dimensions		7
Operation & control		
General		8
Control panel		
How to change values and settings		
Menu guide		9
Installed options		
1. Menu table user parameters		10
1.1. Main menu		13
Version		
Language		
Address		
1.2. Temperature		14
Supply air control		
Outdoor comp. supply air control		
Room control		
ECO-adjustment		
Exhaust air control		
Zonal room control		
Limit for cooling		
1.3. Fan control		15
1.4. Timer		15
Summer-/wintertime		
Activate timer		
Time schedule		
Weekend schedule		
1.5. Inputs/Outputs		16
Status analog inputs		
Status digital inputs		
Status analog outputs		
Status digital outputs		
Calibration of temperature sensors		
1.6. Manual/Auto		16
Filter timer		
1.7. Alarm history		17
1.8. Load settings		17
1.9. Unlock functions		17
1.10. Authorization		17

Options		
Remote panel . Simple		18
Remote panel . 3-way		18
Remote panel . with display		18
Stove mode		20

Maintenance & service		
Cleaning		21
Changing filter		21
Cleaning fans and heat exchanger		21
Disassembly of fan pack and changer		21
Checking the condensate drain		21
Checking the outdoor air intake		22
Service		22
Disposal		22



Checklist installation, adjustment, and start up. **Mounting.**

The unit is mounted according to the recommendations in this manual, section "Installation & adjustment".

 Reheater water.

Water pipes supply and return correctly connected. Red tape = supply, blue tape = return. In addition, in the case of an external battery, check that the reheater is correctly connected to the supply air duct so that the air flow going in the right direction. Valve and actuator installed on the return line. (Electrically, it is normally connected from the factory).

 Freeze protection sensor.

Freeze protection sensor is applied to the return line, insulated and electrically connected. (In the case of internal water coil, this is pre-assembled from the factory).

 Cooling coil.

Refrigerant supply and return correctly connected. Red tape = supply, blue tape = return. In addition, check that the cooling battery is correctly connected to the supply air duct so that the air flow goes in the right direction. Valve and actuator installed on the return line. (Electrically, it is normally connected from the factory).

 Duct-connection.

The units 4 duct connectors are correctly connected to the respective duct.
The out-air connector to the duct coming from outside the house.
The supply air connector to the duct that goes to living-room, bedroom and so on.
The extract air connector to the duct from kitchen, bathroom and so on.
The exhaust air connector to the duct that goes out of the house.

 Sensor connection.

The out-air sensor is placed in the out-air duct.
The supply air sensor is placed in the supply air duct and at least 0,6m after reheater and possibly cooling coil.

 Condensate drain.

Condensate drain connected according to recommendations in this manual, section "Installation & Adjustment".

 Possibly additional accessories.

- | | |
|--|-----------------------------|
| <input type="checkbox"/> Outdoor air damper (ULS): | Check function open / close |
| <input type="checkbox"/> Fireplace switch: | Check function |
| <input type="checkbox"/> Remote panel easy (TG-R4): | Check function |
| <input type="checkbox"/> Remote panel with display: | Check function |
| <input type="checkbox"/> Remote panel 3-way: | Check function |

 Airflows adjusted.

When all airflows are correctly adjusted, note the fan's normal %-rates here in the manual.
Supply air fan normal: _____ % Extract air fan normal: _____ %

 Program function.

It is appreciated if the function of the digital inputs is noted below.

DI1: Not active, Min flow, Boost flow, Max flow, Kitchen, ECO, Stove, AH On/Off, Normal.

DI2: Not active, Min flow, Boost flow, Max flow, Kitchen, ECO, Stove, AH On/Off, Normal.

DI3: Not active, Min flow, Boost flow, Max flow, Kitchen, ECO, Stove, AH On/Off, Normal.

DI6: Not active, Min flow, Boost flow, Max flow, Kitchen, ECO, Stove, AH On/Off, Normal.

 Save settings.

When everything is ready, please save the settings by activating the "Save settings" function. (Then all settings can be revoked in the event of future service if something should go wrong). See the Technical Manual for more info!

Date: _____

Name: _____

Short menu overview

The basic user functions can be accessed by scrolling with the arrow %down+from the main menu. For detailed info, please study the menu structure and associated info text on the following pages in the manual.

In the menu:

- **Temperature**, you set the temperature wished.
- **Fan control**, you control the fans.
- **Timer**, you set your weekly schedule for different fan speeds if you wish.
- **In/outputs**, the status of in and outputs is shown.
- **Manual/Auto**, different functions can be controlled manually.
- **Alarm history**, you can see the latest alarms, but you cannot acknowledge.
- **Load settings** is it possible to reload latest saved settings.
- **Unlock functions**, you can activate additional functions (contact REC for help).
- **Authorization**, you log in for advanced settings, if you are a technician.

Filter change

When it's time to change the filters, the normally green LED above the unit change to red, at the same time the existing text on the line "Mode" in the display is alternated with the text "Change filter".

New filters can be ordered from REC Indovent AB at www.rec-indovent.se or telephone 031-675500.

Follow the description below. Feel free to also watch our instructional video on Youtube:

<https://www.youtube.com/watch?v=sfyC7MEdPyM&t=24s>

- Switch of the power.
- Open the unit's door.
- Remove the long Cover plate.
- Take hold of the filter or of the clamp between the bags. Push the front part backwards, downwards.
- The supply air filter is behind the inner cover plate, behind the exhaust filter. Remove the filter.
- Clean accessible surfaces if necessary.
- Fit the new filters in reverse order (the blue, exhaust air filter, is fitted in the front).
- Refit the cover plate.
- Close the door.
- Turn on the power.



Reset the filter alarm by acknowledging the alarm. Press the red button on the display, then press ok 2 times then left arrow once.

General description

RT 250/400S-EC-RS is an air handling unit (compact cabinet) designed for ventilation of homes, offices, nurseries or other smaller premises.

The Temovex unit is intended to be placed in heated spaces such as laundry room, boiler room, corridor or similar.

The system consists in its standard version of a counterflow heat exchanger, two fans, two filters, reheater, bypass damper and a control system.

Placement guide



1. Casing

The casing is made of hot galvanised sheet metal with 30 mm insulation between the sheets. As a standard, the side panels and the front are powder coated in white. The front door has a magnetic strip which keeps the door closed. The unit top has sleeve connections where all ducts are connected.

2. Exhaust air filter

Coarse 60%, bag (art. No. Q120101)

3. Bypass damper

The Temovex AHU has an automatic bypass damper which makes the air bypass the heat exchanger whenever heat recovery is not necessary. The bypass setting is adjusted on the control panel.

4. Exhaust air fan

The unit has low-energy fan of EC type with integrated overheating.

5. Supply air fan

The same type as exhaust air fan (see point 4)

6. Heat exchanger

Temovex counterflow heat exchanger is designed by our own staff and is the result of 30 years experience of high efficient counterflow heat exchangers.

The heat exchanger is made of thin aluminium sheets, and is completely sealed between the supply air and exhaust air. This is important in order to avoid odours and other contaminants to seeping through to the fresh air side. The heat exchanger has no moving parts, which eliminates wear.

7. Supply air filter

ePM1-50%, bag (art. No. Q120100).

8. Inspection door

When cleaning the heat exchanger or controlling the condensate drain, the Inspection door is opened. (See chapter "Maintenance & service").

9. Adjustable feet

The cabinet has adjustable rubber feet.

10. Condensate drain

The Temovex unit is fitted with a condensate drain at the bottom of the unit. This should be connected to a drain or fed to a floor drain.

11. Control panel

All settings for fan speed, reheating, bypass etc. are made via the control panel and the AHU's integrated control system.

If you have added optional parts to your Temovex AHU, these functions, too, are set via the control panel.

12. Reheater

RT 250/400S-EC-RS is fitted with an electric reheater, 0.9 kW.

As an optional extra, a reinforced electric reheater, 1,8 kW, or a water coil (two different sizes) for waterborne heating is offered. The heater is integrated in the unit and settings are made via the control panel.

In the case of a water coil, the water connections are at the top of the unit, dimension DN12.

RT 250/400S-EC-RS with water coil includes a two-way valve and valve motor in the delivery from REC.

Functional diagram

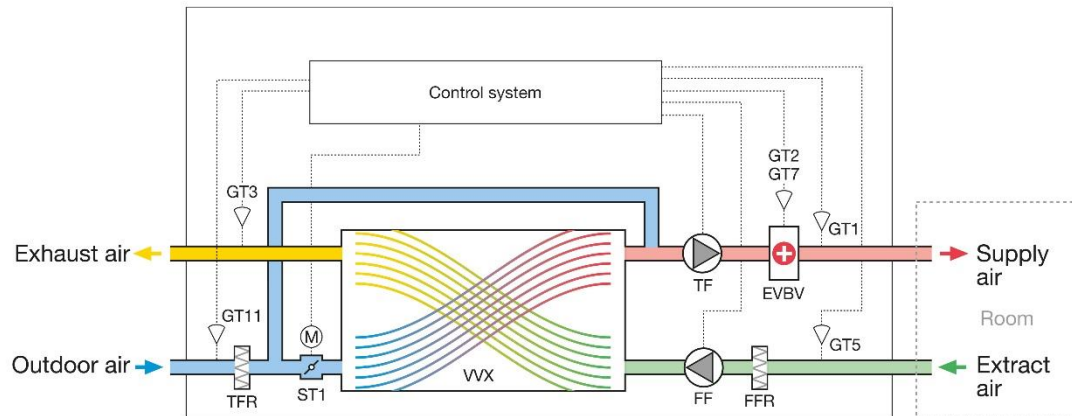

- | | | | |
|------|---|-----|---|
| VVX | Counterflow heat exchanger | TF | Fan, Supply air |
| ST1 | Bypass damper | FF | Fan, Exhaust air |
| EVB | Reheater, electricity/water | GT2 | Over heat protection (with electric heater) |
| GT1 | Temperature sensor, Supply air (red sensor) | GT3 | Temperature sensor, Exhaust air (yellow sensor) |
| GT11 | Temperature sensor, outdoor air (blue sensor) | GT7 | Freeze protection (when water coil) |
| TFR | Filter, Supply air (Outdoor air) | GT5 | Temperature sensor, Extract air (green sensor) |
| FFR | Filter, Exhaust air | | |

Technical specification

	Electric heater		Water heater	
	RT250	RT400	RT250	RT400
Rated electric power (total)	1041 W	1145 W	141 W	245 W
fans	134 W	238 W	134 W	238 W
heater	900W		-	-
Extended heater (option)	900W		-	-
Power, water coil small	-		1150 W ¹	1500 W ¹
Power, water coil big (option)	-		2000 W ¹	2800 W ¹
Water connection	-		DN12	
Voltage/Frequency	230 V, 50 Hz			
Fuse	10 A			
Filter, supply air / exhaust air	Bag: art nr. Q120100 / Bag: art nr. Q120101			
Weight	100 kg			
Brandklass	A15			
Dimensions (WxDxH)	430x620x1900 mm			
Duct connections	4 x Ø160 mm			
Condensate drain	¾+			
Storage Temperature Range	-20 δ . +50°C			
Operating Temperature	0 δ . +50°C			

¹At water temp. 55/45 °C and 70% of maximum flow.

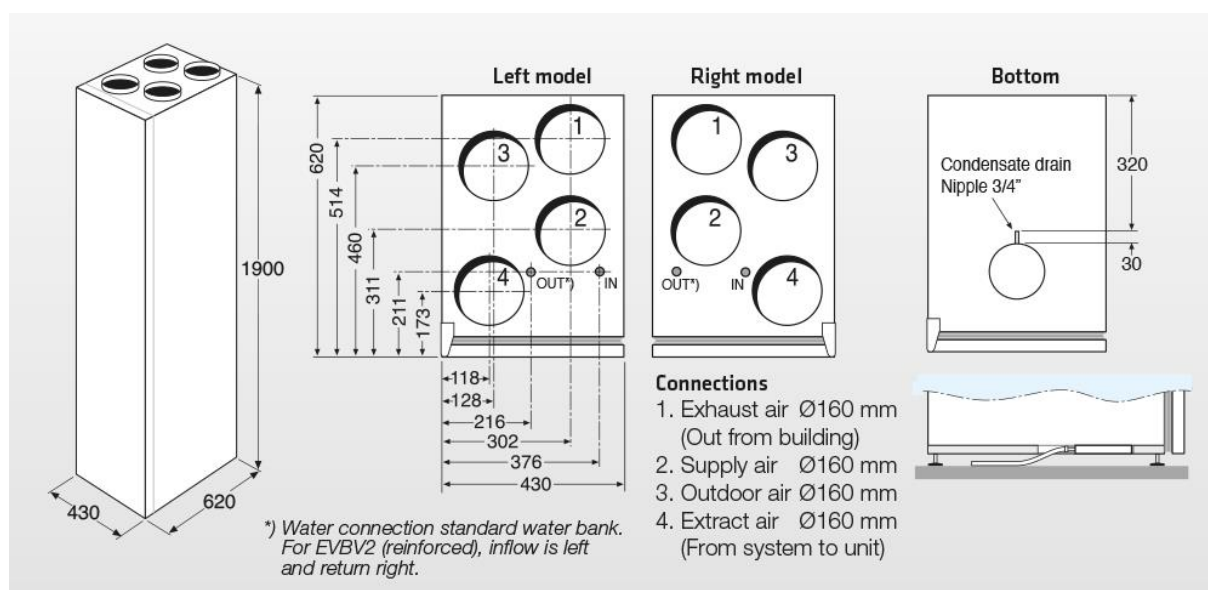
Dimensions

General

This is a description of the basic functions that you can modify to suit your own preferences and circumstances. The unit's control system optimizes the function according to the settings you make. As a user of the air handling unit it is good to know the following:





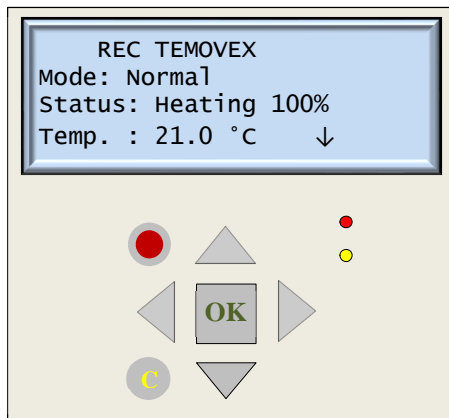

In the menus for heating and cooling, where you as a user have the possibility to make changes, the %auto mode+ is the most optimized function. Should you choose a manual setting, On or Off, the manual settings take precedence.

The unit's various settings and the status of different values such as temperature etc. Can be viewed by scrolling around in the menu system. Certain parameters and operational settings can also be changed. No basic system configurations can be changed without authorization code (technician level).

There is a main menu that the system automatically reverts to approx. 25 minutes after the keys have been last touched. The system also automatically logs you out after this time if you have logged in with a code.

Control unit



-  Up
-  Down
-  Right
-  Left
-  Confirm
-  Show alarm
-  Delete

● Alarm	Flashing	There are one or more alarms that have not been acknowledged.
	Steady	There are one or more acknowledged alarms left.
● Setting	Flashing	You are in a menu where it is possible to change some parameters.
	Steady	You are now in change position.

How to change values and settings

Scroll to the desired menu using the arrow keys. Press %OK+, and the adjustable variable will start blinking. Change with the up or down arrow keys. Moving between lateral positions is done with the right or left arrow key. When the correct value is set, confirm with %OK+. The cursor then moves to the other alterable variable in the same menu.

Menu guide

On the next page is a table that represents all menus in the program. The table also shows the default setting for each parameter. If the unit, on delivery, deviates from the standard on any parameter, this is marked in the table. (Any changed settings during installation, commissioning or thereafter should also be noted in the table). Below is a small guide to how the menu table is structured. The table also contains references to sections further back in the manual, with in-depth information about each menu.

Parameter	Default setting	Changed setting of this unit
1.1 Temperature		
1.1.1. Supply air temp. (is displayed if supply air control is selected)		
Setpoint	18,0 _C	<input type="checkbox"/> _____ _C (10,0 . 40,0 _C)
1.1.2. Supply air temp. (is displayed if outdoor compensated supply air control is selected)		
1.1.2.1. Outdoor comp. setp.		
-20 _C	25 _C	<input type="checkbox"/> _____ _C
-15 _C	24 _C	<input type="checkbox"/> _____ _C
-10 _C	23 _C	<input type="checkbox"/> _____ _C
-5 _C	23 _C	<input type="checkbox"/> _____ _C
0 _C	22 _C	<input type="checkbox"/> _____ _C
5 _C	20 _C	<input type="checkbox"/> _____ _C
10 _C	18 _C	<input type="checkbox"/> _____ _C
15 _C	18 _C	<input type="checkbox"/> _____ _C
1.1.3. Room temp. (is displayed if room control is selected)		
Setpoint	21,0 _C	<input type="checkbox"/> _____ _C (10,0 . 28,0 _C)
ECO adjust.	2,0 _C	<input type="checkbox"/> _____ _C (0 . 10 _C)
1.1.4. Extract air temp. (is displayed if extract air control is selected)		
Setpoint	21,0 _C	<input type="checkbox"/> _____ _C (10,0 . 28,0 _C)
ECO adjust.	2,0 _C	<input type="checkbox"/> _____ _C (0 . 10 _C)
1.2 Fan control		
Fan mode	Auto	<input type="checkbox"/> Min. flow, <input type="checkbox"/> Boost flow, <input type="checkbox"/> Max flow, <input type="checkbox"/> Stove, <input type="checkbox"/> Kitchen, <input type="checkbox"/> ECO, <input type="checkbox"/> Fire, <input type="checkbox"/> Off

Jump to the next column with the arrow key right.

Jump to the next row with the down arrow key.

Sections in the manual with in-depth information on the current parameter.

If the setting is changed: select and enter the current value.

Menu text shown on the display.

Possible setting range.

Extra infotext.

Possible choices beyond standard.

Installed options this unit

<input type="checkbox"/> Cooling	<input type="checkbox"/> ECO	<input type="checkbox"/> ECO2
<input type="checkbox"/> Outdoor air damper (ULS)	<input type="checkbox"/> Remote panel - Easy (TG-R4)	<input type="checkbox"/> Cp-heater
<input type="checkbox"/> Condensation boiler (KAVK)	<input type="checkbox"/> Remote panel . With display	<input type="checkbox"/> Cp-chiller
<input type="checkbox"/> Stove	<input type="checkbox"/> Remote panel . 3-way	<input type="checkbox"/>

1. Menu table user parameters

Parameter	Default setting	Changed setting of this unit
1.1. REC TEMOVEX (Main menu)		
Mode	(Display of current operating mode)	
Status	(Display of status)	
Temp.	(Display of current setpoint)	
1.1.1. Version		
Version	2.4-1-00	
S/N	(Display of DUC serial no.)	
(Date and time)	"Current date and time"	<input type="checkbox"/> "Current date and time"
1.1.1.1. Choose language		
	English	<input type="checkbox"/> Polish, <input type="checkbox"/> Swedish
1.1.1.1.1. Address		
PLA	254	_____
ELA	30	_____
IP	(Display of current value)	_____
1.2. Temperature		
1.2.1. Supply air temp. (is displayed if supply air control is selected)		
Actual (Supply air temp.)	(Display of current value)	
Setpoint	18,0 _C	_____ _C (10,0 . 40,0 _C)
Outdoor air temp.	(Display of current value)	
Extract air temp.	(Display of current value)	
Exhaust air temp.	(Display of current value)	
Freeze P. temp. (Appears if water heater)	(Display of current value)	
1.2.2. Supply air temp. (is displayed if outdoor compensated supply air control is selected)		
OD temp.	(Display of current value)	
Supply air temp. Act.	(Display of current value)	
Comp.SP	(Display of current value)	
Extract air temp.	(Display of current value)	
Exhaust air temp.	(Display of current value)	
Freeze P. temp. (Appears if water heater)	(Display of current value)	
1.2.2.1. Outdoor comp. Setp.		
-20 _C	25 _C	_____ _C
-15 _C	24 _C	_____ _C
-10 _C	23 _C	_____ _C
-5 _C	23 _C	_____ _C
0 _C	22 _C	_____ _C
5 _C	20 _C	_____ _C
10 _C	18 _C	_____ _C
15 _C	18 _C	_____ _C
1.2.3. Room temp. (is displayed if room control is selected)		
Actual (Room temp.)	(Display of current value)	
Setpoint	21,0 _C	_____ _C (10,0 . 28,0 _C)
ECO adjust.	2,0 _C	_____ _C (0 . 10 _C)
Outdoor air temp.	(Display of current value)	
Supply air temp.	(Display of current value)	
Extract air temp.	(Display of current value)	
Exhaust air temp.	(Display of current value)	
Freeze P. temp. (Appears if water heater)	(Display of current value)	
1.2.4. Extract air temp. (is displayed if exhaust air control is selected)		
Actual (Extract air temp.)	(Display of current value)	
Setpoint	21,0 _C	_____ _C (10,0 . 28,0 _C)
ECO adjust.	2,0 _C	_____ _C (0 . 10 _C)
Outdoor air temp.	(Display of current value)	
Supply air temp.	(Display of current value)	
Exhaust air temp.	(Display of current value)	
Freeze P. temp. (Appears if water heater)	(Display of current value)	
1.2.5. Room temp. bedroom (appears if zone control is selected)		
Actual (Room temp. bedroom)	(Display of current value)	
Setpoint	19,0 _C	_____ _C (10,0 . 28,0 _C)
ECO adjust.	2,0 _C	_____ _C (0 . 10 _C)
Outdoor air temp.	(Display of current value)	
Supply air temp.	(Display of current value)	
Extract air temp.	(Display of current value)	
Exhaust air temp.	(Display of current value)	

Freeze P. temp. <i>(Appears if water heater)</i>	(Display of current value)	
1.2.5.1. Room temp. living room <i>(appears if zone control is selected)</i>		
Actual <i>(Room temp. living room)</i>	(Display of current value)	
Setpoint	21,0 _C	_____ _C (10,0 . 28,0 _C)
ECO adjust.	2,0 _C	_____ _C (0 . 10 _C)
Supply air temp.	(Display of current value)	
1.2.6. Cooling limit <i>(is displayed if cooling is factory activated)</i>		
Outd. temp.	>20,0 _C	_____ _C
Hysteresis	1,0 _C	_____ _C
1.3. Fan control		
Fan mode	Auto	<input type="checkbox"/> Min. flow, <input type="checkbox"/> Boost flow, <input type="checkbox"/> Max flow, <input type="checkbox"/> Stove, <input type="checkbox"/> Kitchen, <input type="checkbox"/> ECO, <input type="checkbox"/> Fire, <input type="checkbox"/> Off
Speed	(Display of the selected setting)	
SAF	(Display of current value and setpoint.)	
EAF	(Display of current value and setpoint.)	
1.4. Timer		
Time	"Current time"	<input type="checkbox"/> "Current time"
Date	"Current date"	<input type="checkbox"/> "Current date"
1.4.1. Summer/wintertime		
Adjust clock automatically for summertime	Yes	<input type="checkbox"/> No
1.4.2. Activate timer	No	<input type="checkbox"/> Yes
The timer controls	Min. flow <i>(Display of current selection. See pkt. "Timer" in section -Configuration-)</i>	
1.4.2.1. Schedule		
Monday		
Period 1	08:00 . 17:00	_____
Period 2	00:00 . 00:00	_____
Monday->Friday		
Period 1	08:00 . 17:00	_____
Period 1	00:00 . 00:00	_____
Tuesday		
Period 1	08:00 . 17:00	_____
Period 2	00:00 . 00:00	_____
Wednesday		
Period 1	08:00 . 17:00	_____
Period 2	00:00 . 00:00	_____
Thursday		
Period 1	08:00 . 17:00	_____
Period 2	00:00 . 00:00	_____
Friday		
Period 1	08:00 . 17:00	_____
Period 2	00:00 . 00:00	_____
Saturday		
Period 1	00:00 . 00:00	_____
Period 2	00:00 . 00:00	_____
Saturday->Holiday		
Period 1	00:00 . 00:00	_____
Period 1	00:00 . 00:00	_____
Sunday		
Period 1	00:00 . 00:00	_____
Period 2	00:00 . 00:00	_____
Public holiday		
Period 1	00:00 . 00:00	_____
Period 2	00:00 . 00:00	_____
1.4.2.2. Holiday schedule		
Holiday (mm:dd)		
1	01-01 - 01-01	_____
2	01-01 - 01-01	_____
3	01-01 - 01-01	_____
4	01-01 - 01-01	_____
5	01-01 - 01-01	_____
6	01-01 - 01-01	_____
7	01-01 - 01-01	_____
8	01-01 - 01-01	_____
9	01-01 - 01-01	_____

10	01-01 - 01-01	_____
11	01-01 - 01-01	_____
12	01-01 - 01-01	_____
13	01-01 - 01-01	_____
14	01-01 - 01-01	_____
15	01-01 - 01-01	_____
16	01-01 - 01-01	_____
17	01-01 - 01-01	_____
18	01-01 - 01-01	_____
19	01-01 - 01-01	_____
20	01-01 - 01-01	_____
21	01-01 - 01-01	_____
22	01-01 - 01-01	_____
23	01-01 - 01-01	_____
24	01-01 - 01-01	_____

1.5. In/Outputs

1.5.1. Analoga inputs *(no settings, only display of current values)*

A11 OD temp	(Display of current value)	_____
A12 SA temp	(Display of current value)	_____
A13 EXT temp	(Display of current value)	_____
A14 EA temp	(Display of current value)	_____
UAI1	(Display of current setting and value)	_____
UAI2	(Display of current setting and value)	_____
UAI3	(Display of current setting and value)	_____
UAI4	(Display of current setting and value)	_____

1.5.2. Digital inputs *(no settings, only display of current values)*

DI1	(Display of current setting and value)	_____
DI2	(Display of current setting and value)	_____
DI3	(Display of current setting and value)	_____
DI4 SA Fan	(Display of current alarm status.)	_____
DI5 EA Fan	(Display of current alarm status.)	_____
DI6	(Display of current setting and value)	_____
DI7	(Display of current setting and value)	_____
DI8 Filter alarm	(Display of current alarm status.)	_____

1.5.3. Analog outputs *(no settings, only display of current values)*

AO1 SA fan	(Display of current value)	_____
AO2 EA fan	(Display of current value)	_____
AO3 Heater	(Display of current value)	_____
AO4 Chiller	(Display of current value)	_____

1.5.4. Digital outputs *(no settings, only display of current values)*

DO1 BP opening	(Display of status)	_____
DO2 BP closing	(Display of status)	_____
DO3	(Display of current setting and status)	_____
DO4	(Display of current setting and status)	_____
DO5	(Display of current setting and status)	_____
DO6	(Display of current setting and status)	_____
DO7	(Display of current setting and status)	_____

1.5.5. Calibrate sensors

A11	0,0	_____
A12	0,0	_____
A13	0,0	_____
A14	0,0	_____
UAI1	0,0	_____
UAI2	0,0	_____
UAI3	0,0	_____
UAI4	0,0	_____

1.6. Manual/Auto

SA controller	Auto	<input type="checkbox"/> Off, <input type="checkbox"/> Manual _____ % (0 . 100 %)
Supply air fan	Auto	<input type="checkbox"/> Off, <input type="checkbox"/> Manual _____ % (0 . 100 %)
Exhaust air fan	Auto	<input type="checkbox"/> Off, <input type="checkbox"/> Manual _____ % (0 . 100 %)

Heater	Auto	<input type="checkbox"/> Off, <input type="checkbox"/> Manual _____ % (0 . 100 %)
Duct heater <i>(appears if Zone Control is enabled)</i>	Auto	<input type="checkbox"/> Off, <input type="checkbox"/> Manual _____ % (0 . 100 %)
BP / By-pass damper	Auto	<input type="checkbox"/> Off, <input type="checkbox"/> Manual _____ % (0 . 100 %)
Pos.	(Display of current status)	
Chiller <i>(appears if cooling is enabled)</i>	Auto	<input type="checkbox"/> Off, <input type="checkbox"/> Manual _____ % (0 . 100 %)
ULS / OD air damper <i>(appears if ULS is enabled)</i>	Auto	<input type="checkbox"/> Off, <input type="checkbox"/> On
KAVK / Cond. boiler <i>(appears if KAVK is enabled)</i>	Auto	<input type="checkbox"/> Off, <input type="checkbox"/> On
CP / Circ. pump heater <i>(appears if CP-heater is enabled)</i>	Auto	<input type="checkbox"/> Off, <input type="checkbox"/> On
CP / Circ. pump chiller <i>(appears if CP-chiller is enabled)</i>	Auto	<input type="checkbox"/> Off, <input type="checkbox"/> On
1.6.1. Filter timer <i>(appears if Filter timer is enabled)</i>		
Interval	12 months	_____ months (6 . 18 months)
Set zero	No	<input type="checkbox"/> Yes
1.7. Alarm history		
(Displays info about the latest alarm events)		
1.8. Load settings		
Load saved settings	No	<input type="checkbox"/> Yes
1.9. Unlock functions		
Input code	0	_____
1.10. Authorization		
Log in		
State code	****	_____
Cur. level	(Display of current login level)	

1.1. REC TEMOVEX (Main menu)

Mode shows current fan mode. The unit can operate in several modes, depending on temperature and commands given to the unit etc. The options available are Stop, Low, Normal, Boost, Max, Kitchen mode, Stove mode, Night cooling, Defrost, ECO, Fire, ECO2 and Safe mode. For more info, please see the respective mode in the manual.

Status shows the current heating/cooling level and % output. Possible modes are Heating xx%, Bypass xx% and cooling xx%. If all have 0% output, ----- 0 % is shown.

Temp shows current temperature set-point.

1.1.1. Version

Displays program version and control-electronics manufacturing number. Current date and time are also shown, which also can be changed here.

1.1.1.1. Language

Select Swedish, English, or Polish.

1.1.1.1.1. Address

This shows the unit's address. Can be changed.

1.2. Temperature

Temperatures

Outdoor temperature is measured on incoming air at the point where the sensor is located. The sensor is placed in the outdoor air duct as far from the unit as possible. The temperature may differ slightly from the actual outside temperature, which may depend on the length of the duct, insulation etc.

Supply air temperature is measured in the supply air duct normally about one meter away from the unit. Supply air is the fresh air that, after possible heating, is sent to the room.

Exhaust air temperature is measured in the exhaust air duct close to the unit. Exhaust air is the air that leaves the room and returns to the unit.

Extract air temperature is measured in the extract air duct close to the unit. Extract air is the air that, after the heat has been recovered, leaves the unit, and is sent out of the house.

Room temperature is measured using an external sensor located in an appropriate place in the apartment/house.

Frost protection temperature is only used with water-based heating and shows the temperature of the return water from the heating coil. When the water temperature is too low the unit will stop, to prevent freezing of the water coil.

Control mode

What is displayed under temperature depends on the type of control mode selected. There are five different control modes to choose from depending on the application: a) supply air control, b) cascaded exhaust air control, c) cascaded room control, d) outdoor compensated supply air control and e) zonal room control.

For the temperature setting and readout, select the column below corresponding to your configuration.

1.2.1. Supply air control

This function is selected if you have a primary heating source other than ventilation, such as underfloor heating or radiators. The temperature of the supply air is regulated by means of the supply air sensor. The setpoint for the supply air is suitably set a few degrees lower than what the primary heating system is set for.

1.2.2. Outdoor compensated supply air control

This function is the same as above with the difference that the setpoint changes in relation to the outdoor temperature. The function can be used, for example, if the home is greatly affected by heat and cold, for example through large windows.

1.2.2.1. Outdoor compensated setpoint

Enter the setpoint for the supply air, at the different outdoor temperatures stated, and the program calculates a curve and controls according to that. What the currently setpoint is, can be seen in the menu.

1.2.3. Room control

At room control, a room sensor must be installed. The temperature of the supply air is then regulated to achieve the desired temperature in the room (setpoint value on the room sensor). The function is suitably used when ventilation also is the primary source of heating.

ECO adjustment

ECO adjustment is used if you want to lower the indoor temperature a few degrees, to save energy when you are not at home. A temperature range is specified, within which heating, and cooling are inactive. For example, with ECO adjustment 2 degrees and a setpoint of 20, heating and cooling will be inactive between 18 and 22 degrees. For this to work, the ECO function must be activated at the factory.

1.2.4. Extract air control

This function is a slightly simpler room control. You do not need a room sensor, but the temperature in the room is represented by the temperature in the extract air duct and control takes place for a constant extract air temperature according to set setpoint.

ECO adjustment

See section 1.2.3. above.

1.2.5. Zone control

This is a more advanced form of room control, where you can have two zones with different temperatures such as one temperature in the bedroom and another in the living room. However, it requires a little extra equipment such as extra heaters and sensors etc.

1.2.6. Limit for cooling

The default setting is that cooling is not activated until the outside temperature is above +20 degrees. If you want to change this, set the outdoor temperature at which the cooling can start. There is also an adjustable hysteresis so that the cooling does not open and close all the time if the temperature is around the set value.

1.3. Fan control

In the operating menu you can set which mode the fans should run in. You can also see if the fans are running at fixed speed or variable. You can also see current values and setpoints. The set values are seen within parentheses.

Fan mode

In the fan control the following six modes are always available:

- Auto: The most optimal mode. This automatically controls the temperature acc. to the built-in and optimized algorithms of the system.
- Min flow: This forces the system to run with the set minimum flow.
- Boost: This forces the system to boost the flow. Useful if you, for example, quickly would like to air out.
- Max flow: In this mode the fans run with maximum flow.
- Kitchen flow: Used while the cooker fan is used. During kitchen flow the supply air fan normally has a higher flow than the exhaust air fan to compensate for the air that the cooker fan extracts.
- Off: In this mode all fans are off.

The following three modes are available if the feature is installed and configured. Even if the feature is not configured, it is visible and can be selected, but the system will after a few seconds revert to the previous selection.

- Stove: Used when a stove is being used. In the stove mode normally the supply air fan has a higher flow than the exhaust air fan to compensate for the air that the stove extracts.
- ECO: Only used with room control or exhaust air control when you are not home. The fans go down to minimum flow but are gradually increasing to normal flow based on heating or cooling needs. ECO adjust gives a temperature range around the setpoint where neither heating nor cooling is active.
- Fire: Not used on this unit!

1.4. Timer

In the timer setting menu, the clock can be set, and the timer configured.

1.4.1. Summer / wintertime

This menu allows you to indicate if the time should be adjusted automatically for summer/wintertime.

1.4.2. Activate timer

The timer is not activated on delivery but by default connected to the function Min. flow. The timer must be activated if you want the times set under the time and holiday schedule to work. If you want to use the timer for other than Min. flow, you change this in the configuration menu. See the Technician's Manual. ATTENTION! If you use the timer to start and stop the unit at certain times, it is the time when the unit should be running that you set in the schedule.

1.4.2.1. Time schedule

There is an option of two periods per day. NOTE! If you want the timer active from e.g., Monday 20:00 until Tuesday 06:00 the setting should be Monday Per 2: 20:00 . 24:00 and Tuesday Per 1: 00:00 . 06:00. If you have the same times recurring every day in the week you can use the function Monday → Friday.

If you want the same times on both Saturday, Sunday, and all holidays (specified in the holiday settings), you can use the macro function Saturday → Holiday.
Otherwise, there is a special menu for the holiday times.

1.4.2.2. *Weekend schedule*

Up to 24 separate holiday periods for a full year can be set. A holiday period can be any number of days, from 1 to 365, in sequence. The dates are in the format: MM:DD (Imagine that you are entering a period from 00:00 one day until 00:00 the next day. For example, holiday June 6th is written 06:06 . 06:07.) When the current date falls within a holiday period the operating period for %Holiday+will be used.

1.5. Inputs/Outputs

In this menu the status of all inputs and outputs can be controlled.
Sensors can also be calibrated.

1.5.1. *Status analog inputs*

This shows all the system's current temperatures.

The universal inputs can be configured for different purposes such as temperature or 0-10V input. Can be eg room sensors, anti-freeze sensors or pressure sensors, etc. Current values of resp. entrance are displayed.
Temperature in _C and pressure in Pa.

%Not active+means the input is not used (nothing is configured for the input).

1.5.2. *Status digital inputs*

"On" means that the system has detected a signal (24V) from the sensor/switch connected to the input.

"Off" therefore means that no signal (0V) is detected.

The alarm inputs can assume the status ok or Alarm.

DI4 and 5 are permanently allocated to fan alarms and normally show "OK".

DI8 (filter alarm) is not used, because the filter alarm has a timer on this unit.

1.5.3. *Status analoga outputs*

AO1-AO2 shows the current output voltage to the fans (TF=Supply air fan, FF=Exhaust air fan).

AO3 shows the current output voltage to the heater. Not sure that it is this output that controls the heat. It depends on the configuration. If it is, for example, electric heating, it is controlled via digital output. However, the heating equipment can always be seen on this output, 0-10V corresponds to 0-100% heat.

AO4 shows the cooling equipment if cooling is installed.

1.5.4. *Status digital outputs.*

DO1 and 2 are permanently allocated for bypass control.

DO3 is normally used to control the electric heating if this is available. If there is no electric heating, the output can under certain conditions be used for other purposes if there is a shortage of outputs in the application.

DO4-DO7 are relay outputs that can be configured for various functions. "On" means that the relay is activated and "Off" therefore means that the relay is not activated.

1.5.5. *Calibration of temperature sensors*

This gives the possibility to adjust the value for the temperature sensors up or down. (Set an offset value). May, for example, be used to synchronize the old normal thermometer with the system temperature. Input the difference here and they will display the same values.

1.6. Manual/Auto

In Manual/Auto a great number of functions may be controlled manually, which is very useful for commissioning and troubleshooting.

That any output is controlled manually means that the normal regulation is put out of action. Therefore, a C alarm is generated as soon as any output is set to a mode other than auto.

1.6.1. Filtrertimer

In this menu, you can set the interval you want between filter changes. The menu also shows how many months remain before the filters should be changed. ATTENTION! This value is only updated once a day. This means that, if "Interval" is changed, "Time left" is not updated until the next day.

When it is time to change filter, this is indicated on the display on the row %Mode+ by having the existing text alternate with the text %Change filter+.

ATTENTION! If you change the filter prematurely (before the prompt in the display comes), you should reset the timer in this menu so there is the correct time interval for the next change.

On the other hand, if you have been prompted to change the filter, you reset the timer by acknowledging the alarm in the usual way.

You can also do reset in this menu if you wish.

1.7. Alarm

Current alarm

Current alarm and its status can be seen by pushing the red button.

Here the alarms may also be acknowledged, blocked, or unblocked (allow alarm).

An alarm that was confirmed, but where the error was not fixed will show as a confirmed error in the menu. As soon as the error is fixed it will disappear from the menu (since it is already confirmed).

Some errors cause the unit to stop immediately, as it may be dangerous to allow regulation to continue.

You can also block an alarm to run the unit despite the alarm. **NOTE!** This you should not be done without proper knowledge since it may cause danger and in worst case damage to property.

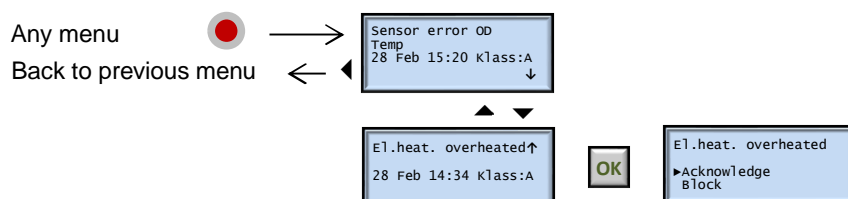

Alarm history

This shows the 21 latest alarm activities. E.g., when the alarm was triggered, when it was confirmed and/or reset etc. No alarms may be confirmed, blocked etc here.

Example of alarm history:



1.8. Load settings

This reloads previously saved settings into the DUC, or if you have never saved anything the default settings. All settings are loaded except date and time.

1.9. Unlock functions

Used if you add functions afterwards. Please contact your supplier!

1.10. Authorization

This is where a technician with proper access rights may log in to adjust the system and if necessary, change certain parameters.

Options

Remote panel Ę Simple (art.no. Q100446)



Remote panel - Simple

Remote panel - Simple (TG-R4) contains a temperature sensor and a set-point knob. The unit is used as a room thermostat, but also allows you to shift the set-point within a certain range.

The normal set-point is entered on the ventilation unit display and based on this value the set-point may be adjusted using the knob on the Remote Panel . Simple plus or minus a few degrees.

The adjusted set-point is shown on the main menu of the unit display. Remote panel . Simple uses analog transmission of values to the unit.

Remote panel Ę 3-way (art.no. Q100543)



Remote panel . 3-way

Simple remote panel for easy activation of normal mode, minimum mode (ECO) and forced mode.

Even potential alarms (red LED) are indicated on the panel.

Remote panel Ę with display (art.no. Q101299)



Remote panel . with display

← Away mode
← Adjustment keys
← Menu selection

Remote panel . with display is the most advanced remote panel. This also contains a temperature sensor and can be used as a room thermostat. It also has a display and some keys allowing you to see different temperatures and set them. You can also set the fan speed and see a lot of other information. In addition, it has an away key+built in.

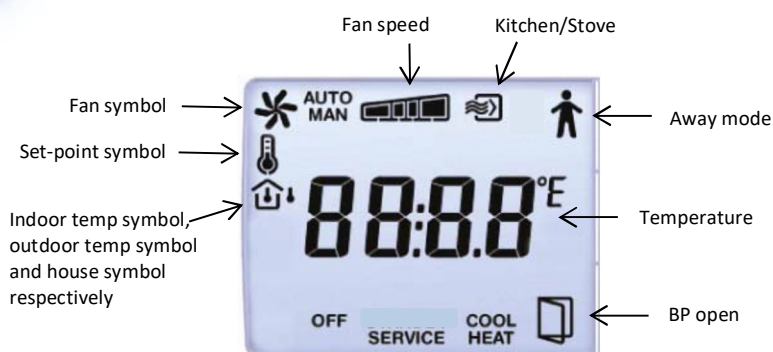

Temperature set-point display.

Normally (when you have not touched any key for the last 10 s) the set-point is shown on the display at the same time as the indoor temperature symbol and the house symbol are turned on.

Change of the temperature set-point.

Pushing once on the menu selection key will cause the set-point symbol to start flashing and the possibility is given to change the set-point using the adjustment keys. The value is saved when no keys have been touched for 10 s and the display reverts to showing the set-point.

Display of actual temperature.

Pushing once more (within 10 s) on the menu selection key will turn off the set-point symbol, the indoor temperature symbol will start flashing and the display will show the actual value. The adjustment keys have no function in this case. When the keys have not been touched for 10 s, the display will revert to showing the set-point.

Display of the outdoor temperature.

Pushing once more (within 10 s) on the menu selection key will turn off the indoor temperature symbol. At the same time the outdoor temperature symbol is turned on and the outdoor temperature is shown in the display. The adjustment keys have no function in this case. When the keys have not been touched for 10 s, the display will revert to show the set-point.

Fan speed:

Pushing once more (within 10 s) on the menu selection key will turn on the fan symbol and the fan speed as well as MAN or AUTO. The fan symbol will start flashing and the fan speed can be changed by stepping around to the desired mode (min, normal, forced, or max) with the adjustment keys. The modes correspond to the setting in the menu selection Mode on the main display and a change on the remote panel will also be shown on the main panel.

The symbol MAN indicated that the unit is using a different mode than AUTO.

It may be that the unit is in a speed between min and max and normal and forced respectively due to forced or safe mode. The symbol fan speed will show the actual fan mode according to the following:

- | | |
|-------------------------------------|--|
| • At fan speed 0 | no box filled. |
| • < normal mode | leftmost box turned on |
| • = normal mode | the two leftmost boxes are turned on |
| • > normal mode but < = Forced mode | the three leftmost boxes are turned on |
| • = max mode | all boxes turned on |

If the unit on the main display is run manually using Hand/Auto the fan speed will not be changed when changed on the remote panel. What happens is that the changes are made on the symbols of the display and on the main panel in the menu Mode but are not implemented on the fans until you exit the manual mode in Hand/Auto.

The new setting is saved when you continue with menu selections or after not having touched the keys for 10 s and the display reverting to showing the set-point.

Kitchen/Stove.

The symbol kitchen/stove is turned on when the unit is operated in the stove or kitchen mode.

Away mode/ECO mode.

Pressing the away key will turn off the away mode symbol and the unit changes to ECO mode.

An additional press will make the mode revert.

The mode assumes that ECO is activated on the unit under system.

Bypass.

The bypass symbol is turned on when the bypass is > 0 % open.

Cool.

COOL is turned on if cooling is selected under system and the cooling valve is open > 0 %.

Heat.

HEAT is turned on if the controller requests > 0 % heating.

Alarm.

SERVICE is turned on if there is an unconfirmed alarm on the unit.

Off.

OFF is turned on if the unit is in the off mode.

Stove mode



Extent.

The stove mode must be activated from the factory to make the stove mode work. In addition to the software configuration a momentary switch is included in the function (To connect and configure please see the Technician Manual). The stove mode means reduced exhaust air and increased supply air during the initial time after the stove has been lit. It means that the cooling is blocked so that you do not cool out the nice heating from the stove.

Start of stove timer.

Pushing once on the switch starts the stove mode and a timer starts counting down at the same time. If you regret the choice, you can easily turn off the mode with a new push on the switch.

Stove indication.

That the stove mode is active is indicated on the indicator lamp in the switch.

For more extensive functional description see the Technician Manual under the section I/O configuration.

Cleaning

Keep the unit clean for maximum performance and long service life. The filters should be changed at least once a year or more frequently if necessary. The fans and heat exchangers must be cleaned according to the instructions below.

Changing filters

The Temovex unit has two filters, exhaust air filter and outdoor air filter (fresh air). The filters should not be washed but replaced with new ones. New filters can be ordered from REC Indovent AB at www.rec-indovent.se or phone 031-675500.

 The unit must not be operated without the intended original filters. Operation without filters seriously affects the performance of the unit and can damage the unit's fans and heat exchangers.

Instructions for changing the filter see page 4.

The unit operates even if the filters are dirty, but the performance would be less good, energy consumption increases and heat recovery decreases.

Cleaning the fans

- Switch of the power.
- Open the unit's door.
- Remove both covers.
- Disconnect the fan's electric plug and pull out the fan. (Clean one fan at a time).
- Clean the impeller using a brush or compressed air.
- Refit the fans in reverse order.
- Refit the covers.
- Close the door.
- Turn on the power.



 **NOTE!** The fans must under no circumstances be cleaned under running water!



Cleaning the heat exchanger

- Switch of the power.
- Open the unit's door.
- Remove both fans (see above).
- Open the inspection door by the bottom of the unit.
- Remove the red plug at the bottom of the unit, the condensate drain.
- Flush the heat exchanger with hot water.



NOTE! If the unit is fitted with a condensate evaporator unit (KAVK), a wet vac should be used to deal with the rinse water.

A degreasing agent may be required if the heat exchanger is very dirty.

 **NOTE!** The agent must be of a type which is not aggressive to aluminium. Alkaline detergents with caustic ammonia and alike must never be used, since they have a corrosive action on aluminium, i.e. ruin the heat exchanger.

- Refit the red plug (On the same side of the unit as the filters).
- Refit the inspection door.
- Refit the fans in reverse order.

 **NOTE!** Make sure the fan motors are not/do not get wet when restarting the unit. If wet, this could be fatal!

- Refit the covers.
- Close the unit door.
- Turn on the power using the main switch.

Checking the condensate drain

- Open the unit's door.
- Open the access door at the bottom of the cabinet.
- Make sure the drain is not blocked. This can be done by pouring some water into the bottom of the unit.

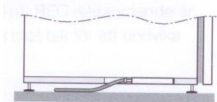

NOTE! On the side which does not have a red plug.

- If the drain is jammed, try to remove the obstruction. If need be, call a plumber.
- Refit the access door.
- Close the unit door.

Checking the outdoor air intake

Once a year the outdoor air intake should be checked. Make sure it is not clogged by for example leaves, snow or ice.

Service

Service and repairs, beyond normal maintenance, should be carried out by professionals in the ventilation field, or - if electricity is involved - by an authorized electrician.



The electric panel must not be opened by other than authorized specialist.



The plates covering the fans must not be removed when the AHU is running, as there is a risk of contact with moving parts. Make sure the electricity has been cut off (unplugged or fuse removed).



Interference with the AHU system may affect the warranty terms.



Use original spare parts only.

Disposal and recycling

The unit has a long service life if it is properly maintained and can be renovated to advantage. Spare parts - see www.shop-recvent.se When the unit is to be disposed of: see information on waste management and recycling on our website.

Prevent accidents when the AHU is disposed of. Remove the cable from the wall socket and cut it as close to the unit as possible. Store and transport the waste unit lying down.

Please leave the unit to be recycled where such facilities exist. Check with your local authority for recycling advice.

Notes:



REC Indovent AB reserves the right to make alterations to specification and construction without prior notification.



REC Indovent AB

Box 37, SE-431 21 Mölndal, Sweden
Visiting address: Kärragatan 2

Tel: +46 31 67 55 00

Fax: +46 31 87 58 45

www.rec-indovent.se