

# 规格书 SPECIFICATION

风机型号 FAN MODEL **B3P400-EC137-901**

## 1. 适用范围 SCOPE

本电动机规格书适用于3相直流无刷电动机的技术规定  
 其中没有特别指明处均遵从中国国家强制性产品认证和CE认证，且满足欧盟ErP要求  
 THIS SPECIFICATION IS SPECIFIED FOR 3-PHASE DC BRUSHLESS MOTOR.  
 ITEMS EXCEPT HAVING INDICATED IN THE SPECIFICATION, ARE APPLIED TO CHINA COMPULSORY PRODUCT CERTIFICATION AND CE, AND TO MEET THE EU ErP REQUIREMENTS.

## 2. 规格 SPECIFICATIONS

项目 ITEM	内容 SPECIFICATION		备注 DESCRIPTION
电气特性 ELECTRICAL CHARACTERISTICS	电压 VOLTAGE	三相 AC380 [V]	范围：三相AC380-460V RANGE
	频率 FREQUENCY	50/60 [Hz]	
	转速 SPEED	2250 ±100 [r/min]	
	功率 POWER	1700 ±16% [W]	
	电流 CURRENT	2.9 ±16% [A]	
	最大风量 AIR FLOW	7600 MAX. [m³/h]	
	噪音 NOISE	87 MAX. [dBA]	测试距离1米
	泄漏电流 LEAKAGE CURRENT	3.5 MAX. [mA]	测试条件 AC520V 3S TESTING CONDITIONS
	绝缘耐压 DIELECTRIC RESISTANCE	AC2200V	1S 跳闸电流10mA TRIPPING CURRENT
	绝缘电阻 INSULATION RESISTANCE	100 MIN. [MΩ]	测试条件 DC500V TESTING CONDITIONS
	绝缘等级 INSULATION CLASS	F 级 CLASS	
	控制方式 CONTROL INPUT	0-10V Vdc/PWM	见图一、二 SEE FIG. 1、2
	输出电源 OUTPUT	+10Vdc	
	转速信号 TACH OUTPUT	12 PULSE/R	占空比DUTY 30%~70%
保护方式： PROTECTED MODE	OVER-TEMPERATURE/OVER-CURRENT/LOCKED PROTECTED		

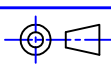
RoHS指令对应 CONFORM TO RoHS INSTRUCTIONS		角度公差 Angle Tolerance		夹角短边的长度范围(unit mm) Classification of a shorter side of subjected angle				普通公差 General Tolerance		尺寸范围 (unit mm) Classification of basic dimension			
		公差Tolerance		X≤10	10<X≤50	50<X≤120	120<X≤400	公差 Tolerance		X≤6	6<X≤30	30<X≤120	120<X≤400
				±1°	±30'	±20'	±10'			±0.1	±0.2	±0.3	±0.5
								材质 MATERIAL	-----	B3P400-EC137-901			
00	'23-03-15	-----	00初版	JSOM28	表面处理 FINISH	-----							
改版 SYM	年月日 DATE	图面变更号 REVISION NO.	变更事项 REVISIONS	设计 BY	风机/电机型号 MODEL								
制图 DRAWN	设计 DESIGNED	检图 CHECKED	检印 CHECKED	比例 SCALE	FREE	品名 TITLE	规格书 SPECIFICATION						
艾弗洛 '23-03-15 JSOM28	艾弗洛 '23-03-15 JSOG01	艾弗洛 '23-03-17 JSOG01	艾弗洛 '23-03-17 JSOG01	三角法 THIRD ANGLE PROJECTION		图号 DWG. NO.	A112-1155-00						
艾弗洛 AFL										页 SHEET	1/6		

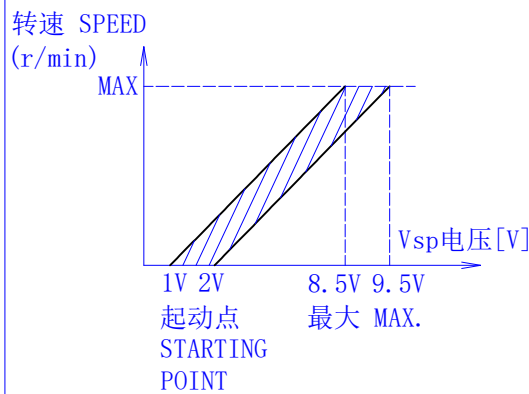

图一 FIG. 1

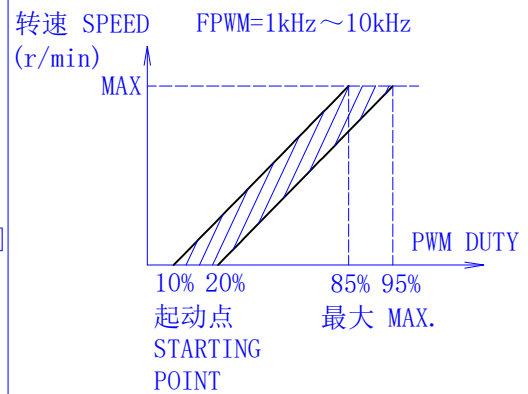

图二 FIG. 2

机械特性 MECHANICAL SPECIFICATION	外观 APPEARANCE	不能有影响商品质量的伤痕和污迹 THERE SHOULD NOT BE ANY DEFECTS AND DIRTY WHICH SPOIL GOODS VALUE
	质量 MASS	约 APPROX 17 [Kg]
	电机引线引拔强度 LEAD WIRE PULLED OUT STRENGTH	20 [N/根]以上 MIN.
	寿命 L10 LIFE	40000 [h] MIN.
	工作方式 RUN MODE	S1
	动平衡标准 DYNAMIC BALANCE STANDARD	G 6.3

## 3. 环境要求 ENVIRONMENTAL REQUIREMENT

保存温度 STORAGE TEMPERATURE RANGE	-40~80	[°C]	
使用·保存湿度 OPERATING, STORAGE HUMIDITY	30~95	[%]RH	无结露 NON CONDENSING
使用温度范围 OPERATING TEMPERATURE RANGE	-25~50	[°C]	

## 4. 使用注意事项 NOTE IN USE

- (1) 本电机内未设接线反接等保护线路  
SINCE THIS MOTOR HAS NO REVERSING CONNECTION
- (2) 风机的电气连接必须有合适的过流保护器以防止电流过大对产品造成损坏  
THE OVER CURRENT PROTECTOR IS NECESSARY IN CASE THE DAMAGE FROM THE OVER CURRENT
- (3) 风机运转时不可插拔风机引线插头  
PLEASE DO NOT PERFORM EXTRACTION AND INSERTION OF THE CONNECTOR UNDER REVOLUTION IRRESPECTIVE OF POWER ON AND POWER OFF
- (4) 若三相电源由接触器或继电器控制开关，风机运行时关闭三相电源，须等待1分钟或一分钟以上再开三相电源。如图：  
IF THE THREE-PHASE POWER SUPPLY IS CONTROLLED BY A CONTACTOR OR RELAY, AND THE THREE-PHASE POWER SUPPLY IS TURNED OFF WHEN THE FAN IS RUNNING, YOU MUST WAIT FOR 1 MINUTE OR MORE BEFORE TURNING ON THE THREE-PHASE POWER SUPPLY. AS SHOWN IN THE FIGURE:

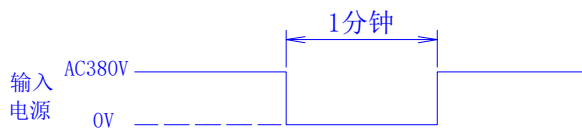

- (5) 本风机通风冷却 使用时请考虑风机周边的通风条件  
FAN CAN BE COOLED BY VENTILATION, PLEASE CONSIDER VENTILATED CONDITION AROUND THE FAN WHEN USING IT
- (6) 轴承部不可受到冲击  
DO NOT ADD SHOCK TO THE BALL BEARING
- (7) 拿取风机时不可拎风机引线 引线过度受力时内部焊接部分可能脱落  
DO NOT CARRY WITH LEAD WIRES WHEN HANDLE A FAN, IF ADD HUGE STRENGTH TO LEAD WIRES THAT THE SOLDERED PART IN FAN MAY BE SHED
- (8) 按本规格书中的规格评价风机 若工作点规格需要变更 请与本公司联系  
EVALUATE THE FAN REFER TO THIS SPECIFICATIONS. IF THE LOAD OR POWER SUPPLY VOLTAGE OF THE MOTOR SHOULD BE CHANGED, PLEASE CONTACT WITH US

## 5. 其它 OTHERS

- (1) 本款风机的知识产权属于本公司 在本款风机的使用上不会发生专利问题 应用本风机形成有关产品或方法及新的技术方案造成专利侵权 本公司不予保证 请贵公司特别注意  
THE INTELLECTUAL ASSET OF THE FAN IN THE FORM OF PATENT BELONGS TO OUR CORPORATION SO ANY PATENT PROBLEM WILL NOT BE CAUSED DURING THE ACTUAL APPLICATION. OUR CORPORATION WILL NOT BE RESPONSIBLE FOR ANY PATENT DISPUTE OR PROBLEM THAT CAUSED BY THE PRODUCT METHOD AND NEW TECHNIQUE PROJECT WHICH ARE DEVELOPED BY USING THIS FAN
- (2) 贵公司保证未经本公司许可 不得将此技术规格书泄漏给其它任何第三方  
IT SHOULD BE ASSURED THAT THIS SPECIFICATION CAN NOT BE REVEALED TO ANY THIRD PARTY WITHOUT THE CONSENT OF OUR CORPORATION
- (3) 本电机Pb Cr(VI+) Cd Hg PBB PBDE 6种物质的含量满足RoHS指令(2002/95/EC)的要求  
MATERIALS OF MOTOR CONTAIN SIX SUBSTANCES Pb Cr(VI+) Cd Hg PBB AND PBDE, THOSE CONTENTS COMPLY WITH THE RoHS INSTRUCTION

## 6. P-Q曲线图 P-Q CURVES

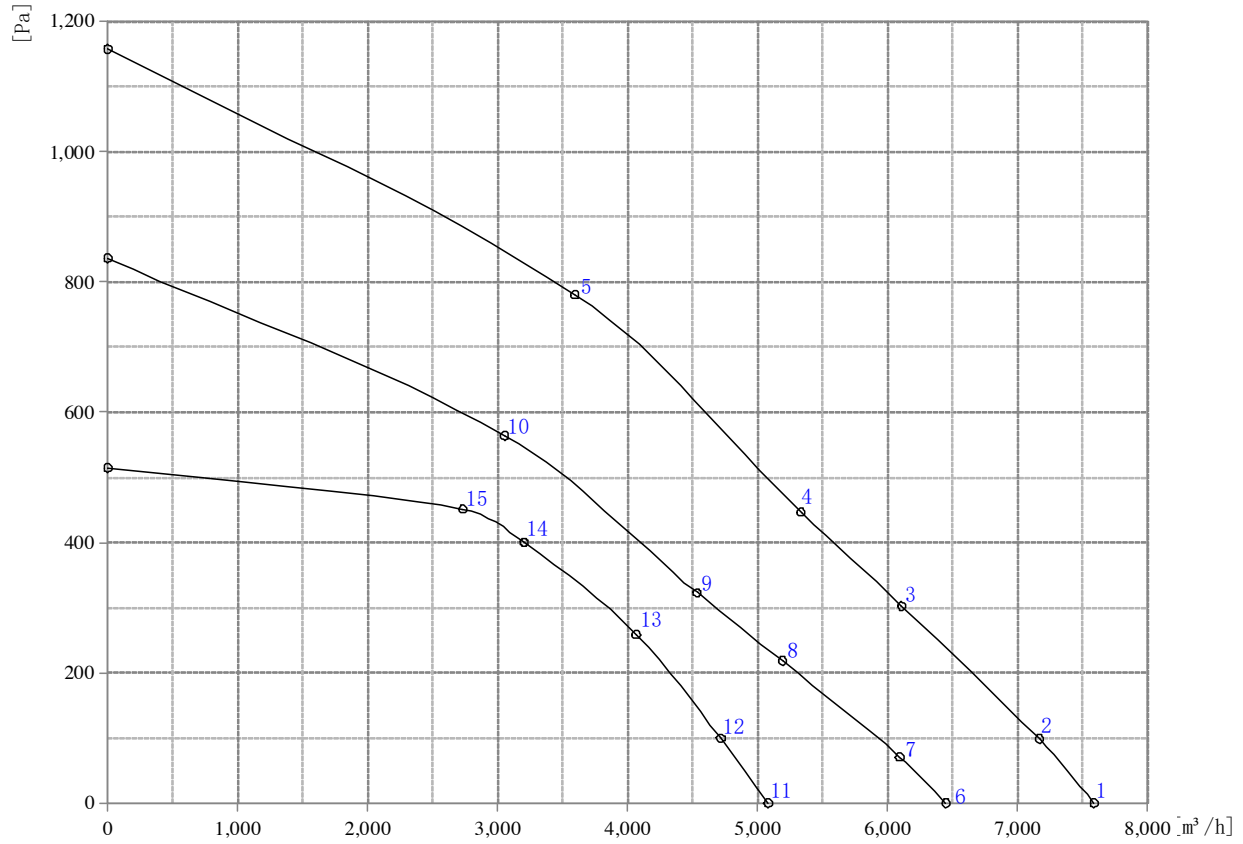

项目 ITEM	电压 VOLTAGE	频率 FREQUENCY	转速 SPEED	功率 POWER	电流 CURRENT	风量 AIRFLOW	静压 PRESSURE	Vsp
单位 UNIT	[V]	[Hz]	[r/min]	[W]	[A]	[m³/h]	[Pa]	[V]
1	三相380V	50	2266	1678	2.81	7586	0	10V
2	三相380V	50	2217	1642	2.75	7166	99	
3	三相380V	50	2064	1541	2.58	6106	303	
4	三相380V	50	1989	1496	2.52	5332	447	
5	三相380V	50	1999	1495	2.52	3591	781	
6	三相380V	50	1926	1030	1.73	6448	0	7V
7	三相380V	50	1884	1008	1.69	6091	71	
8	三相380V	50	1754	946	1.58	5190	219	
9	三相380V	50	1691	919	1.55	4532	323	
10	三相380V	50	1699	918	1.55	3052	564	
11	三相380V	50	1506	516	0.97	5080	0	5.5V
12	三相380V	50	1506	574	1.06	4715	100	
13	三相380V	50	1506	668	1.21	4065	259	
14	三相380V	50	1506	688	1.24	3201	400	
15	三相380V	50	1505	658	1.20	2730	452	

### 7. 控制方式及应用

#### NOTES ON VARIOUS CONTROL POSSIBILITIES AND THEIR APPLICATIONS

A

B

C

D

E

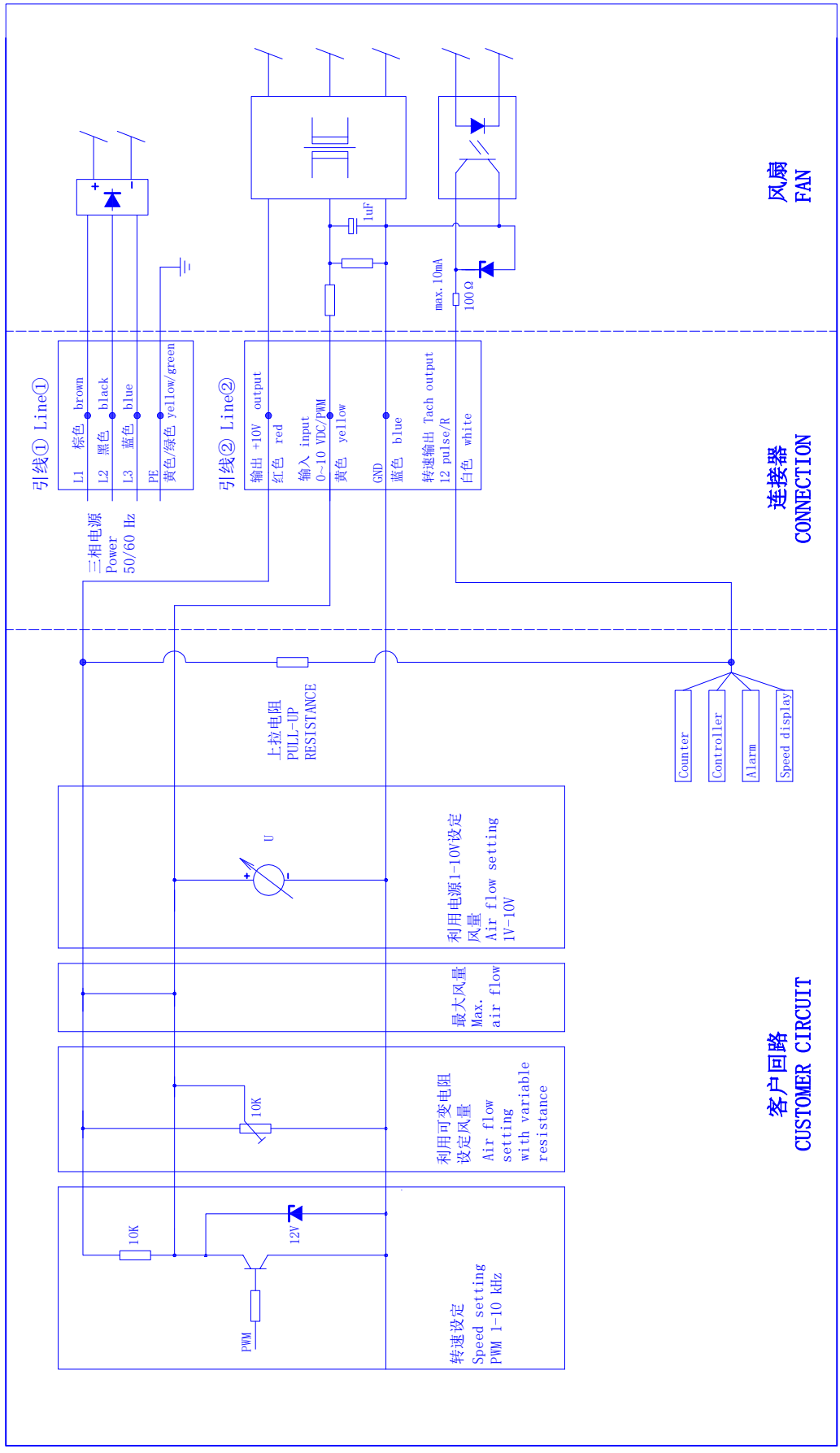

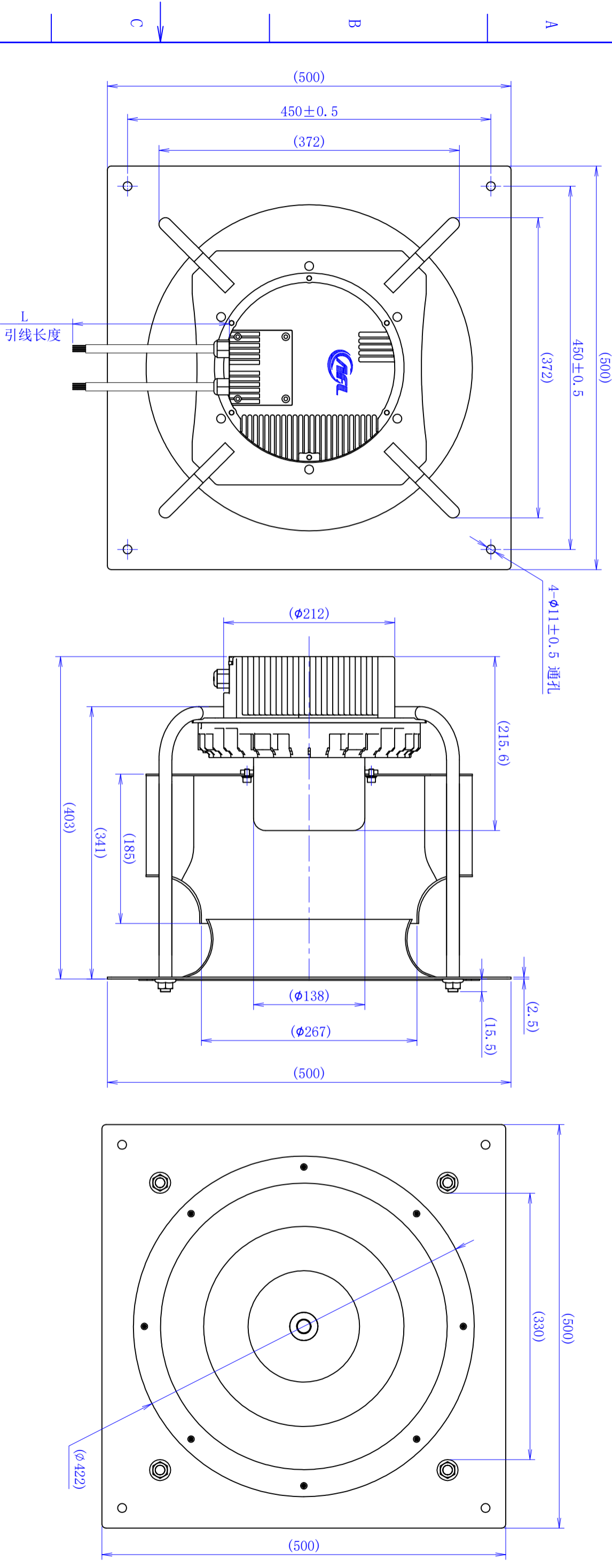

注：引线长度L根据客户需求定制(默认长度1.5米)

【引线①式样】  
【LEAD WIRES ASS'Y ①】

NO.	信号名 SIGNAL	颜色 COLOR	规格 SPEC
1	L1	棕 BROWN	AC380V/50Hz
2	L2	黑 BLACK	AC380V/50Hz
3	L3	蓝 BLUE	AC380V/50Hz
4	PE	黄/绿 YELLOW/GREEN	接地

【引线②式样】  
【LEAD WIRES ASS'Y ②】

NO.	信号名 SIGNAL	颜色 COLOR	规格 SPEC
1	Vcc	红 RED	DC10V输出
2	Vsp	黄 YELLOW	0-10VDC/PWM
3	GND	蓝 BLUE	GND
4	FG	白 WHITE	12 Pulse/R

【铭牌一内容】

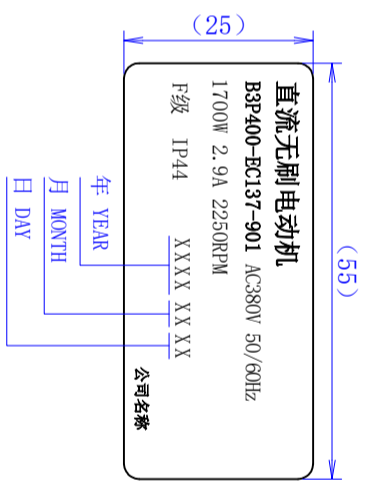

【铭牌二内容】

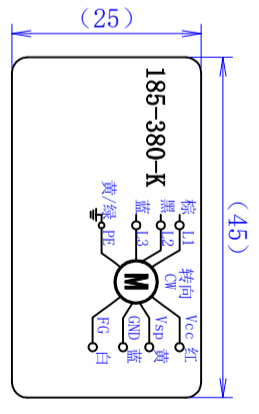

【LABEL ONE CONTENTS】

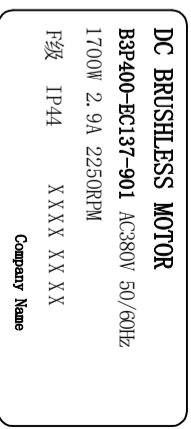

【LABEL TWO CONTENTS】

