

规格书 SPECIFICATION

风机型号 FAN MODEL **B3P400-EC102-001**

1. 适用范围 SCOPE

本电动机规格书适用于3相直流无刷电动机的技术规定
 其中没有特别指明处均遵从中国国家强制性产品认证和CE认证，且满足欧盟ErP要求
 THIS SPECIFICATION IS SPECIFIED FOR 3-PHASE DC BRUSHLESS MOTOR.
 ITEMS EXCEPT HAVING INDICATED IN THE SPECIFICATION, ARE APPLIED TO CHINA COMPULSORY PRODUCT CERTIFICATION AND CE, AND TO MEET THE EU ErP REQUIREMENTS.

2. 规格 SPECIFICATIONS

| 项目 ITEM | 内容 SPECIFICATION | | | 备注 DESCRIPTION |
|---------------------------------------|----------------------------|--|---------|--|
| 电气特性 ELECTRICAL CHARACTERISTICS | 电压 VOLTAGE | AC220 | [V] | 范围: AC200-277V RANGE |
| | 频率 FREQUENCY | 50/60 | [Hz] | |
| | 转速 SPEED | 1430 ±10% | [r/min] | |
| | 功率 POWER | 330 ±16% | [W] | |
| | 电流 CURRENT | 1.5 ±16% | [A] | |
| | 最大风量 AIR FLOW | 3800 MAX. | [m³/h] | |
| | 噪音 NOISE | 70±6 | [dBA] | |
| | 泄漏电流 LEAKAGE CURRENT | 3.5 MAX. | [mA] | 测试条件 AC260V 3S TESTING CONDITIONS |
| | 绝缘耐压 DIELECTRIC RESISTANCE | AC1800V | | 1S 跳闸电流10mA TRIPPING CURRENT |
| | 绝缘等级 INSULATION CLASS | B 级 CLASS | | |
| | 控制方式 CONTROL INPUT | 0-10V Vdc/PWM | | 见图一、二 SEE FIG. 1、2 |
| | 输出电源 OUTPUT | +10Vdc | | |
| | 转速信号 TACH OUTPUT | 12 PULSE/R | | 占空比DUTY 30%~70%须在+10V与TACH OUTPUT间连接10KΩ上拉电阻/IT NEEDS 10KΩ PULL-UP RESISTANCE BETWEEN +10V LINE AND TACH OUTPUT LINE |
| | 保护方式 : PROTECTED MODE | OVER-TEMPERATURE/OVER-CURRENT/LOCKED PROTECTED | | |

| | | | | | | | | | | |
|---|-------------------------|--|---------|----------|-----------|---------------------------|---|--------|----------|-----------|
| RoHS指令对应 CONFORM TO RoHS INSTRUCTIONS | 角度公差 Angle Tolerance | 夹角短边的长度范围 (unit mm) Classification of a shorter side of subjected angle | | | | 普通公差 General Tolerance | 尺寸范围 (unit mm) Classification of basic dimension | | | |
| | 公差 Tolerance | X≤10 | 10<X≤50 | 50<X≤120 | 120<X≤400 | 公差 Tolerance | X≤6 | 6<X≤30 | 30<X≤120 | 120<X≤400 |
| | | ±1° | ±30' | ±20' | ±10' | | ±0.1 | ±0.2 | ±0.3 | ±0.5 |

| | | | | | | | |
|-----------|-------------|-----------------------|-------------------|----------|---------------|-------|------------------|
| 01 | '19-05-17 | EC-AFL-2019-0048 | 2/6页 内容变更 | JSOG01 | 材质 MATERIAL | ----- | B3P400-EC102-001 |
| 00 | '16-04-16 | ----- | 00初版 | JSOG01 | 表面处理 FINISH | ----- | |
| 改版 SYM | 年月日 DATE | 图面变更号 REVISION NO. | 变更事项 REVISIONS | 设计 BY | 风机/电机型号 MODEL | | |

| | | | | | | | | |
|--|----------------------------|----------------------------|----------------------------|----------------------------------|------|----------------|-------------------|-----|
| 制图 DRAWN | 设计 DESIGNED | 检图 CHECKED | 检印 CHECKED | 比例 SCALE | FREE | 品名 TITLE | 规格书 SPECIFICATION | |
| 艾弗洛 '19-05-17 JSOG01 | 艾弗洛 '19-05-17 JSOG01 | 艾弗洛 '19-05-17 JS9S02 | 艾弗洛 '19-05-17 JS9S02 | 三角法 THIRD ANGLE PROJECTION | | 图号 DWG. NO. | A112-0051-01 | |
| 杭州艾弗洛电器有限公司 HANGZHOU AIRFLOW ELECTRIC APPLIANCES CO., LTD. | | | | | | | 页 SHEET | 1/6 |

1

2

3

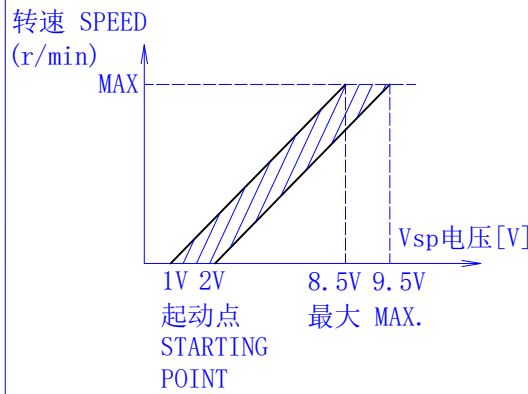

图一 FIG. 1

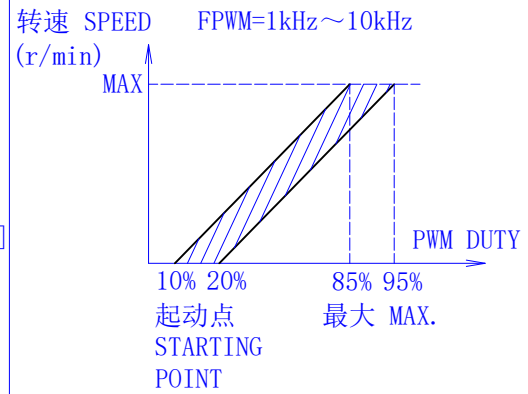

图二 FIG. 2

外观 APPEARANCE

不能有影响商品质量的伤痕和污迹
THERE SHOULD NOT BE ANY DEFECTS AND DIRTY WHICH
SPOIL GOODS VALUE

质量 MASS

约 APPROX 5.5 [Kg]

机械特性
MECHANICAL
SPECIFICATION电机引线引拔强度
LEAD WIRE PULLED
OUT STRENGTH

20 [N/根]以上 MIN.

寿命 L10
LIFE L10

40000 [h] MIN.



3. 环境要求 ENVIRONMENTAL REQUIREMENT

| | | |
|--|----------------------------------|-----------------------|
| 保存温度 STORAGE TEMPERATURE RANGE | -25~60 [°C] | |
| 使用·保存湿度 OPERATING, STORAGE HUMIDITY | 30~95 [%]RH | 无结露 NON CONDENSING |
| 使用温度范围 OPERATING TEMPERATURE RANGE | -20~60 [°C] | |
| | IC散热 HEAT SINK OF IC | 115[°C]以下 MAX |
| | 其他电子部品 OTHER ELECTRONIC PARTS | 85[°C]以下 MAX |
| | 轴承 BALL BEARING | 80[°C]以下 MAX |
| | 卷线 COIL | 120[°C]以下 MAX |

4. 使用注意事项 NOTE IN USE

- | | |
|---|--|
| A | (1) 本电机内未设接线反接等保护线路 SINCE THIS MOTOR HAS NO REVERSING CONNECTION |
| | (2) 起动时电流过大会损坏电机 请防止电流峰值超过2.5A TO PREVENT MOTOR DAMAGED BY OVER STARTING CURRENT, THE PEAK CURRENT CAN NOT EXCEED 2.5A |
| | (3) 风机运转时不可插拔风机引线插头 PLEASE DO NOT PERFORM EXTRACTION AND INSERTION OF THE CONNECTOR UNDER REVOLUTION IRRESPECTIVE OF POWER ON AND POWER OFF |
| | (4) 本风机通风冷却 使用时请考虑风机周边的通风条件 FAN CAN BE COOLED BY VENTILATION, PLEASE CONSIDER VENTILATED CONDITION AROUND THE FAN WHEN USING IT |
| | (5) 轴承部不可受到冲击 DO NOT ADD SHOCK TO THE BALL BEARING |
| | (6) 拿取风机时不可拎风机引线 引线过度受力时内部焊接部分可能脱落 DO NOT CARRY WITH LEAD WIRES WHEN HANDLE A FAN, IF ADD HUGE STRENGTH TO LEAD WIRES THAT THE SOLDERED PART IN FAN MAY BE SHED |
| B | (7) 按本规格书中的规格评价风机 若工作点规格需要变更 请与本公司联系 EVALUATE THE FAN REFER TO THIS SPECIFICATIONS. IF THE LOAD OR POWER SUPPLY VOLTAGE OF THE MOTOR SHOULD BE CHANGED, PLEASE CONTACT WITH US |

5. 其它 OTHERS

- | | |
|---|--|
| C | (1) 本款风机的知识产权属于本公司 在本款风机的使用上不会发生专利问题 应用本风机形成有关产品 或方法及新的技术方案造成专利侵权 本公司不予保证 请贵公司特别注意 THE INTELLECTUAL ASSET OF THE FAN IN THE FORM OF PATENT BELONGS TO OUR CORPORATION SO ANY PATENT PROBLEM WILL NOT BE CAUSED DURING THE ACTUAL APPLICATION. OUR CORPORATION WILL NOT BE RESPONSIBLE FOR ANY PATENT DISPUTE OR PROBLEM THAT CAUSED BY THE PRODUCT METHOD AND NEW TECHNIQUE PROJECT WHICH ARE DEVELOPED BY USING THIS FAN |
| | (2) 贵公司保证未经本公司许可 不得将此技术规格书泄漏给其它任何第三方 IT SHOULD BE ASSURED THAT THIS SPECIFICATION CAN NOT BE REVEALED TO ANY THIRD PARTY WITHOUT THE CONSENT OF OUR CORPORATION |
| | (3) 本电机Pb Cr(VI+) Cd Hg PBB PBDE 6种物质的含有量满足RoHS指令(2002/95/EC)的要求 MATERIALS OF MOTOR CONTAIN SIX SUBSTANCES Pb Cr(VI+) Cd Hg PBB AND PBDE, THOSE CONTENTS COMPLY WITH THE RoHS INSTRUCTION |

D

E

6. P-Q曲线图 P-Q CURVES

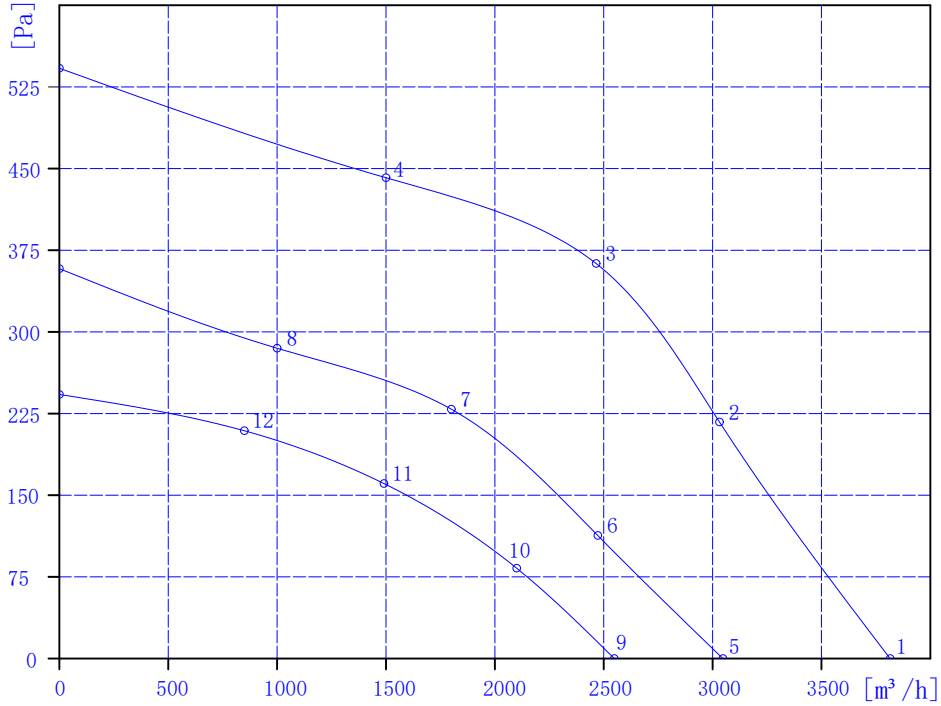

| 项目 ITEM | 电压 VOLTAGE | 频率 FREQUENCY | 转速 SPEED | 功率 POWER |
|------------|---------------|-----------------|-------------|-------------|
| 单位 UNIT | [V] | [Hz] | [r/min] | [W] |
| 1 | 220 | 50 | 1428 | 319 |
| 2 | 220 | 50 | 1424 | 413 |
| 3 | 220 | 50 | 1428 | 435 |
| 4 | 220 | 50 | 1431 | 383 |
| 5 | 220 | 50 | 1153 | 168 |
| 6 | 220 | 50 | 1146 | 204 |
| 7 | 220 | 50 | 1144 | 213 |
| 8 | 220 | 50 | 1137 | 177 |
| 9 | 220 | 50 | 962 | 99 |
| 10 | 220 | 50 | 959 | 120 |
| 11 | 220 | 50 | 963 | 127 |
| 12 | 220 | 50 | 963 | 109 |

1

2

3

7. 控制方式及应用

NOTES ON VARIOUS CONTROL POSSIBILITIES AND THEIR APPLICATIONS

A

B

C

D

E

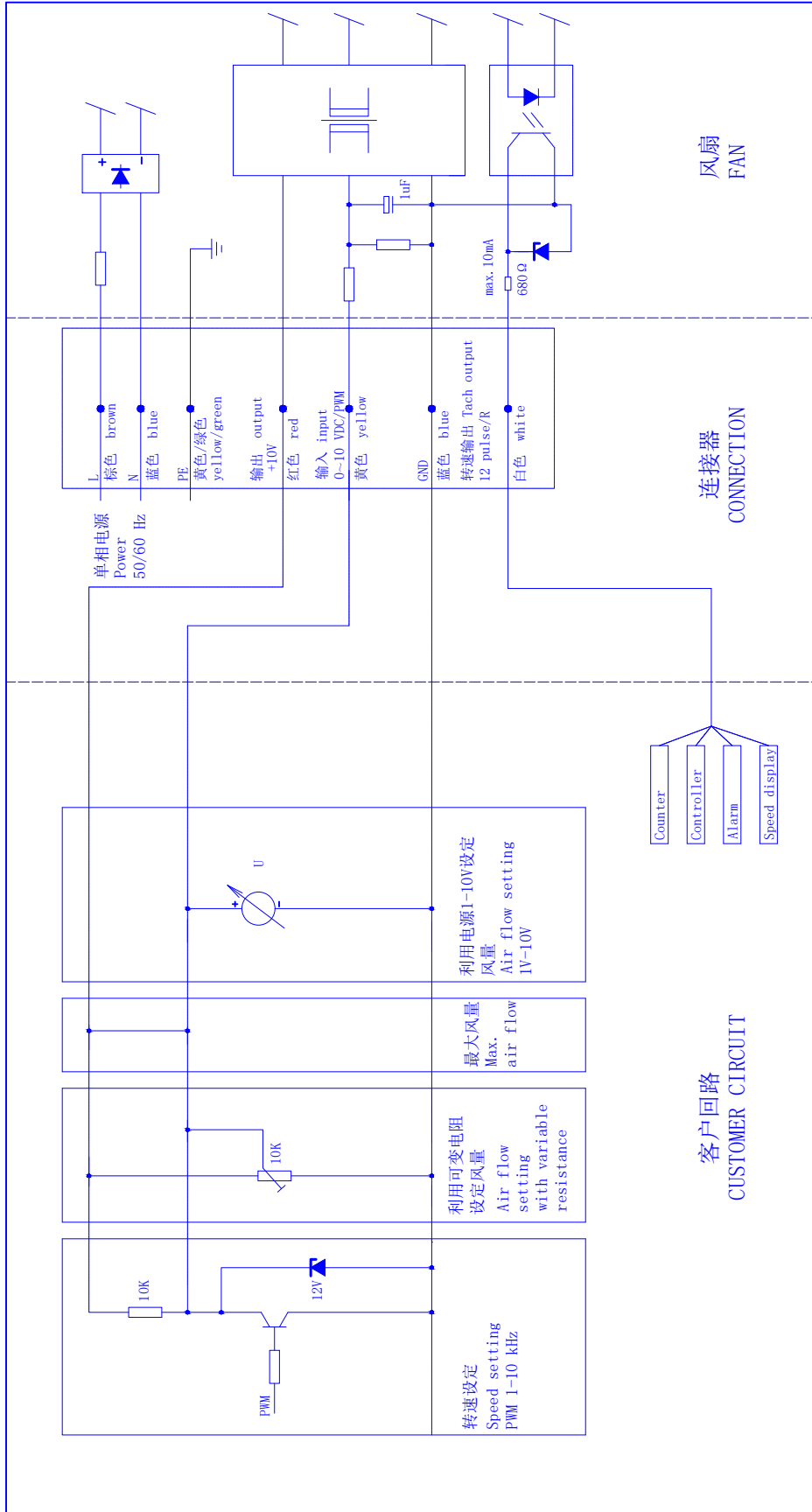

风扇
FAN

连接器
CONNECTION

客户回路
CUSTOMER CIRCUIT

- Counter
- Controller
- Alarm
- Speed display

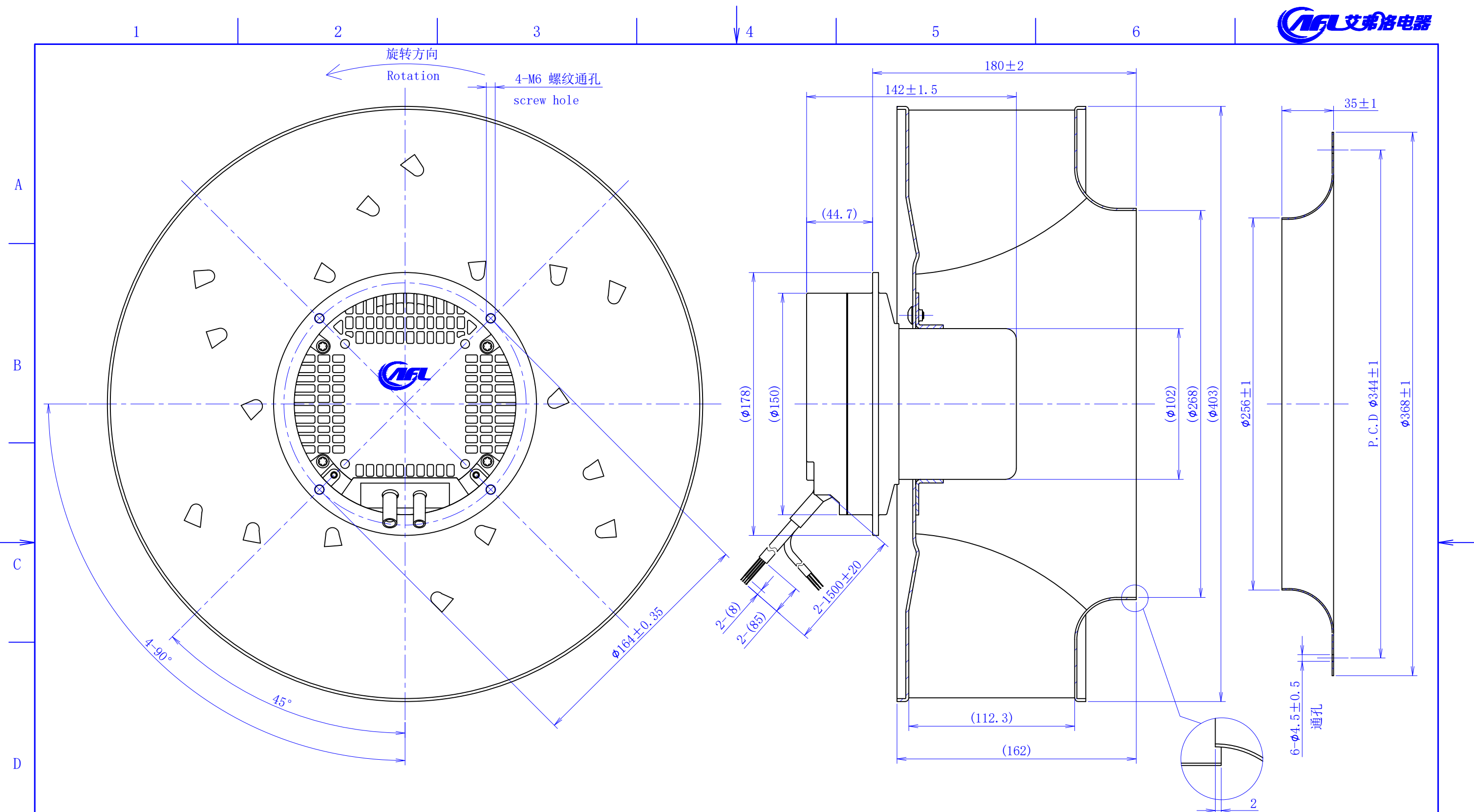

【引线①式样】
【LEAD WIRES ASS'Y ①】
电线 WIRES: 3*AWG18

| NO. | 信号名 SIGNAL | 颜色 COLOR | 规格 SPEC |
|-----|---------------|---------------------|-------------|
| 1 | L | 棕 BROWN | AC220V/50Hz |
| 2 | N | 蓝 BLUE | AC220V/50Hz |
| 3 | PE | 黄/绿 YELLOW/GREEN | 接地 EARTH |

【引线②式样】
【LEAD WIRES ASS'Y ②】
电线 WIRES: 4*AWG22

| NO. | 信号名 SIGNAL | 颜色 COLOR | 规格 SPEC |
|-----|---------------|-------------|------------|
| 1 | Vcc | 红 RED | DC10V输出 |
| 2 | Vsp | 黄 YELLOW | 0-10V/PWM |
| 3 | GND | 蓝 BLUE | GND |
| 4 | FG | 白 WHITE | 12 Pulse/R |

【铭牌一内容】 (55)

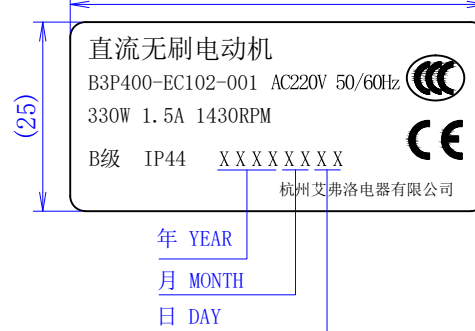

【铭牌二内容】 (45)

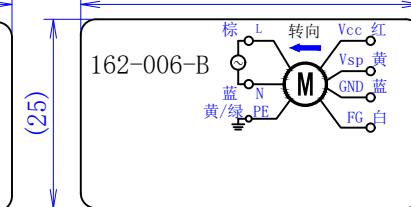

【LABEL ONE CONTENTS】 (55)

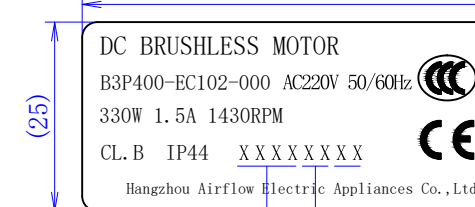

【LABEL TWO CONTENTS】 (45)

